

1. Product Features

- n High speed switching
- n $R_{DS(ON),typ.}=6.5\Omega@V_{GS}=10V$
- n Full isolated TO-3PF plastic package

2. Applications

- n Switching applications

3. Pin configuration

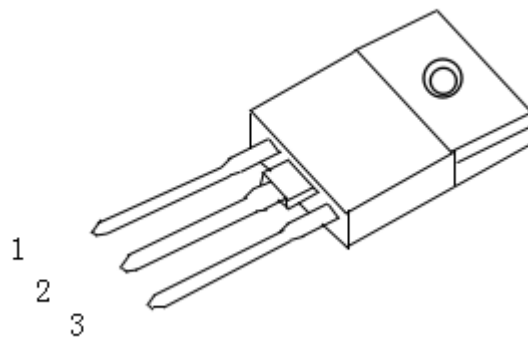

TO-3PF

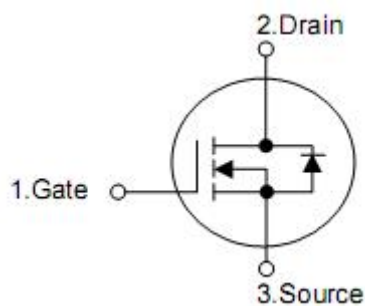

Pin	Function
1	Gate
2	Drain
3	Source

4. Ordering Information

Part Number	Package	Brand
KNL42150A	TO-3PF	KIA

5. Absolute maximum ratings

(T_c= 25 °C , unless otherwise specified)

Symbol	Parameter	Ratings	Unit
V _{DSS}	Drain-to-Source Voltage T _J =25 °C	1500	V
V _{GSS}	Gate-to-Source Voltage	±30	
I _D	Continuous Drain Current @ T _C =25 °C	2.8	A
	Continuous Drain Current@ T _C =100 °C	1.6	
I _{DM}	Pulsed Drain Current at V _{GS} =10V Limited by T _{Jmax}	10	
E _{AS}	Single Pulse Avalanche Energy(V _{DD} =50V)	450	mJ
P _D	Maximum Power Dissipation	63	W
T _{Jmax}	Max. Junction Temperature	150	°C
T _{STG}	Storage Temperature Range	-55 to 150	

6. Thermal characteristics

Symbol	Parameter	Ratings	Unit
R _{θJC}	Thermal Resistance, Junction-to-Case	2	°C /W
R _{θJA}	Thermal Resistance, Junction-to-Ambient	50	

7. Electrical characteristics

(T _J =25°C, unless otherwise specified)							
Symbol	Parameter	Test Conditions	Min.	Typ.	Max.	Unit	
B _V DSS	Drain-to-Source Breakdown Voltage	V _{GS} =0V, I _D =1mA	1500	--	--	V	
R _{DS(ON)}	Drain-to-Source ON Resistance	V _{GS} =0V, I _D =1.3A		6.5	9	Ω	
I _{DSS}	Drain-to-Source Leakage Current	V _{DS} =1500V, V _{GS} =0V	--	--	10	μA	
I _{GSS}	Gate-to-Source Leakage Current	V _{GS} =±20V, V _{DS} =0V	-100	--	100	nA	
R _{gint}	Integrated Gate Resistor		--	2	--	Ω	
V _{GS(TH)}	Gate Threshold Voltage	V _{DS} =V _{GS} , I _D =250μA	3	4	5	V	
C _{iss}	Input Capacitance	V _{GS} =0V, V _{DS} =25V, f=1.0MHZ	--	1500	--	pF	
C _{rss}	Reverse Transfer Capacitance		--	11	--		
C _{oss}	Output Capacitance		--	88	--		
Q _g	Total Gate Charge	V _{DD} =1200V, I _D =2.5A, V _{GS} =10V	--	35	--	nC	
Q _{gs}	Gate-to-Source Charge		--	6	--		
Q _{gd}	Gate-to-Drain (Miller) Charge		--	20	--		
t _{d(ON)}	Turn-on Delay Time	V _{DD} =750V, I _D =1.25A, R _G =4.7Ω V _{GS} =10V (Resistive Load)	T _J =25°C	--	30	--	nS
t _{rise}	Rise Time			--	65	--	
t _{d(OFF)}	Turn-Off Delay Time			--	45	--	
t _{fall}	Fall Time			--	60	--	
I _{SD}	Continuous Source Current		--	--	2.8	A	
V _{SD}	Forward Voltage	I _S =2.5A, V _{GS} =0V	--	-	1.6	V	
t _{rr}	Reverse recovery time	V _{GS} =0V, I _F =2.5A, diF/dt=-100A/μs	--	410	--	ns	
Q _{rr}	Reverse recovery charge		--	2280	--	nC	

8. Test circuits and waveforms

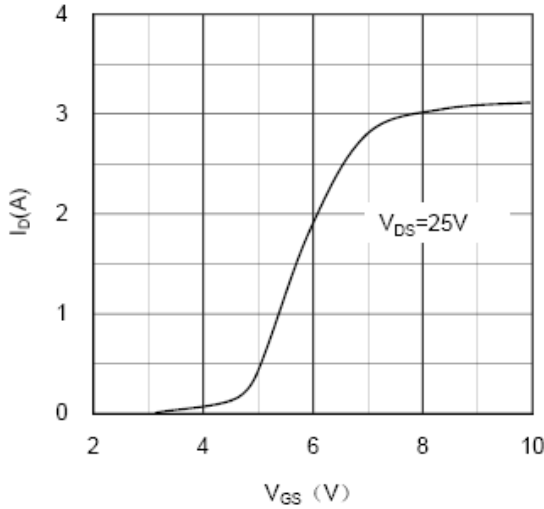

Figure 1. Transfer characteristics

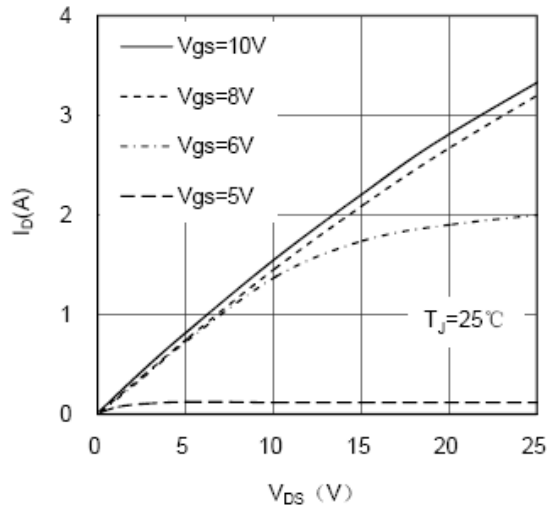

Figure 2. Typical Output Characteristics

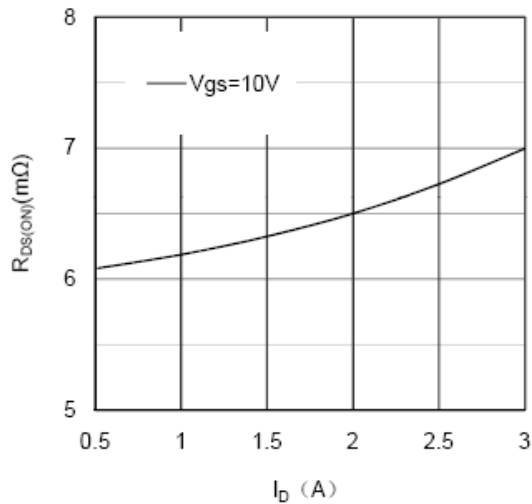

Figure 3. Drain-Source ON Resistance vs I_D

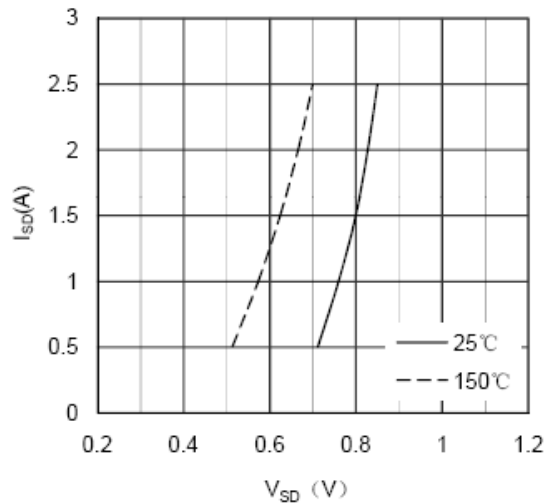

Figure 4. Source-Drain Voltage

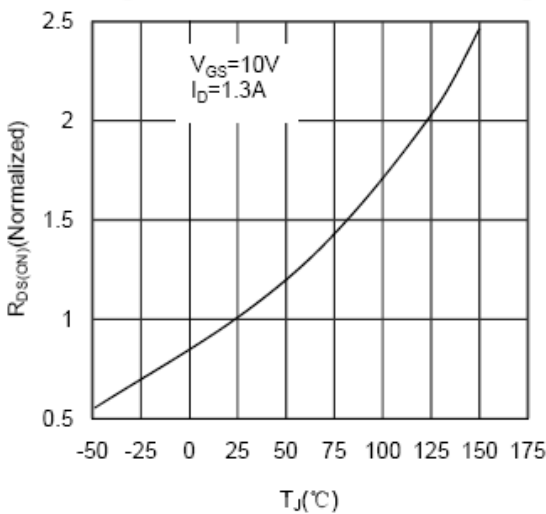

Figure 5. Drain-Source ON Resistance vs Junction Temperature

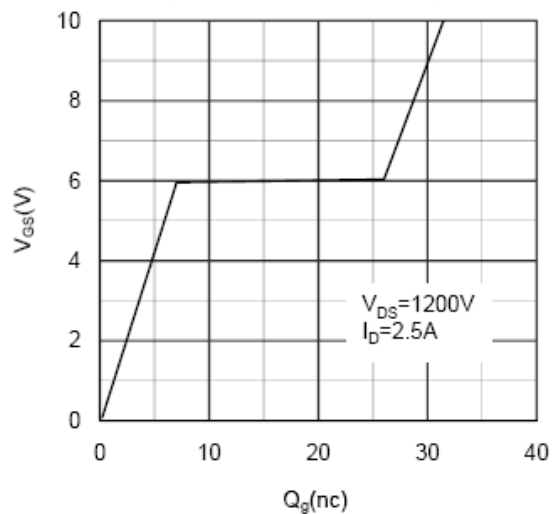

Figure 6. Gate Charge characteristics

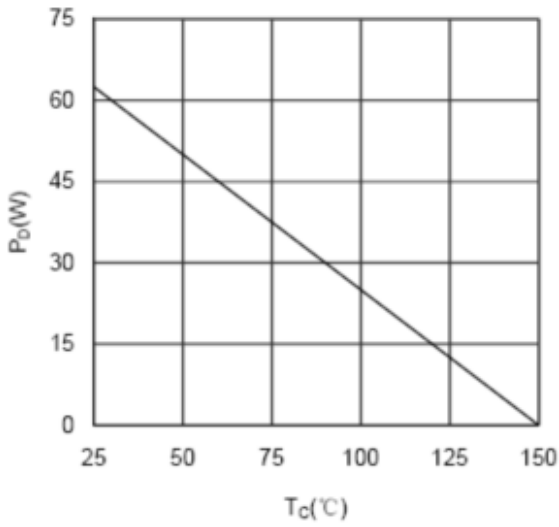

Figure 7. Maximum Power Dissipation vs Case Temperature

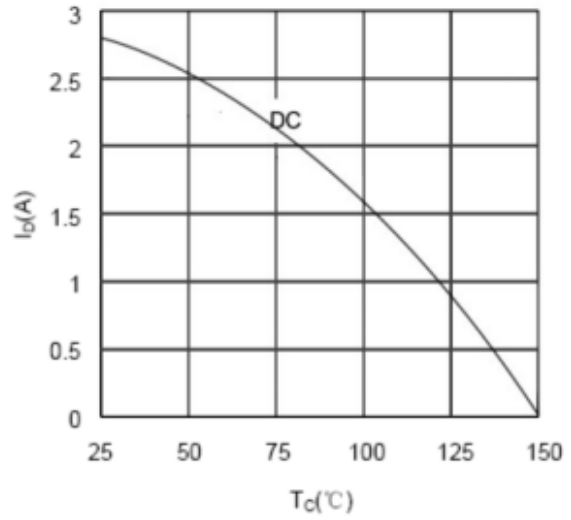

Figure 8. Maximum Continuous Drain Current vs Case Temperature

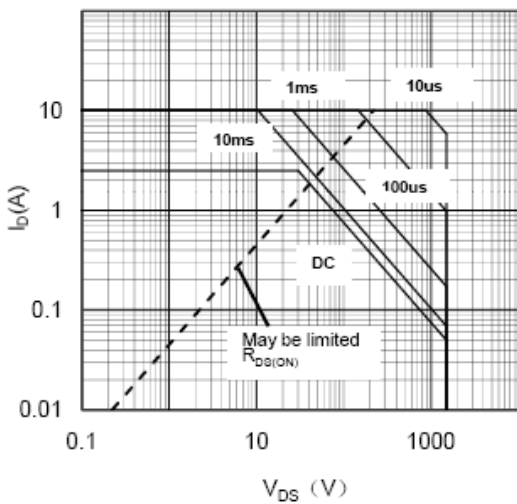

Figure 9. Maximum Forward Safe Operation Area

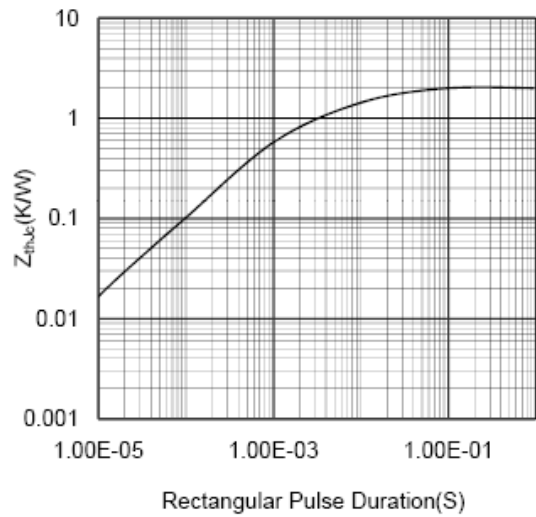

Figure 10. Transient Thermal Impedance